

Nominal data

Type	412 F	
Nominal voltage	VDC	12
Nominal voltage range	VDC	10 .. 14
Speed	min ⁻¹	5400
Power input	W	0.7
Min. ambient temperature	°C	-20
Max. ambient temperature	°C	70
Air flow	m ³ /h	8
Sound power level	B	4.4
Sound pressure level	dB(A)	22.1

ml = Max. load · me = Max. efficiency · fa = Running at free air · cs = Customer specs · cu = Customer unit
Subject to alterations

Technical features

Mass	0.017 kg
Dimensions	40 x 40 x 10 mm
Material of impeller	Fiberglass-reinforced PA plastic
Housing material	Fiberglass-reinforced PBT plastic
Direction of air flow	Air exhaust over bars
Direction of rotation	Left, looking at rotor
Bearing	Sintec sleeve bearing system
Lifetime L10 at 20 °C	45000 h
Lifetime L10 at 60 °C	17500 h
Connection line	Single strands AWG 28, TR 64, bared and tin-plated.
Motor protection	Protected against reverse polarity and locking.
Approval	VDE, CSA, UL
Option	Special options: Speed signal Go / No-go alarm Moisture protection

412 F

DC axial compact fan

Product drawing

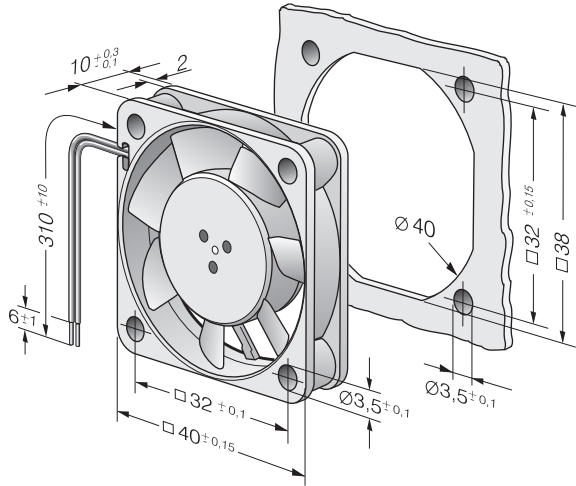

Charts: Air flow

